

T30Z

Automatic Type
Tool Setter
For CNC Machine Centers

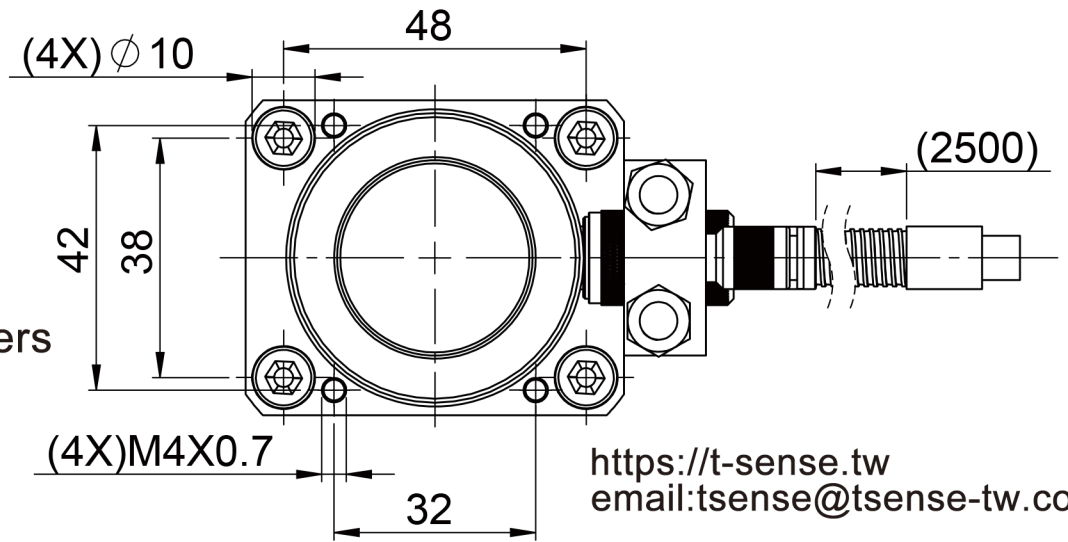

<https://t-sense.tw>
email:tsense@tsense-tw.com

